

General Data

3"WPS®(-CP)

3"WPS® and 3"WPS®-CP pumps are suitable for domestic applications in intermittent operation:

- Domestic water supply
- Small waterworks
- Irrigation
- Tank applications
- Pressure boosting
- Sampling of monitoring wells

Note: For other applications, please contact Well Pumps.

3"WPS®-CP

3"WPS®-CP pumps offer the following features:

- Pump entirely made out of stainless steel and fits in 3" or larger drilled wells
- Constant pressure with two set pressures possible
- Capacity from 0.2 to 7m³/h and a maximum head of 190m
- Motor rating up to 1,5kW, 140Hz
- Single phase supply to the controller
- Incorporated jam free check valve
- Dry-running protection
- High efficiency of pump and motor
- Excellent resistance to wear
- Soft start
- Overvoltage and undervoltage protection
- Overload protection
- Overtemperature protection.
- Variable speed
- Second set-pressure possible

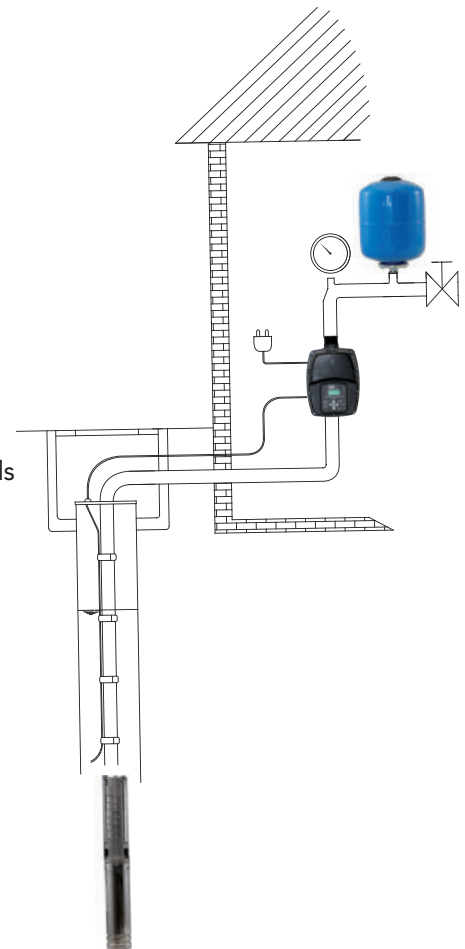

The 3"WPS®-CP pump is fitted with a three phase 230V Well Pumps motor. The 3"WPS®-CP controller needs a single-phase supply and transforms it to a three-phase current to the motor. The controller is equipped with a frequency drive and performs a constant pressure of the flow through a variable speed of the pump. As a consequence, the pump can be set to operate in any duty point in the range between the pump min. and max. performance curves.

In case of a pump fault, an alarm will be indicated on the LCD screen of the 3"WPS®-CP controller.

The 3"WPS®-CP pump is sold as a kit and consists of the following elements:

- A 3" submersible pump WPS® entirely made of stainless steel.
- A WPS® high speed submersible motor able to run at variable frequencies up to 140Hz.
- A WPS®-CP constant pressure controller including a variable speed drive, a flow detection and a pressure sensor.
- A pressure vessel of 8 liter, a valve and a pressure gauge.

3"WPS®

3"WPS® pumps offer the following features:

- Pump entirely made out of stainless steel and fits in 3" or larger drilled wells
- Capacity from 0.2 to 7m³/h and a maximum head of 190m
- Motor rating up to 1,5kW, 140Hz
- Single phase supply
- Incorporated jam free check valve
- Dry-running protection
- High efficiency of pump and motor
- Excellent resistance to wear
- Soft start
- Overvoltage and undervoltage protection
- Overload protection
- Overtemperature protection
- Internal surge arrester

The 3"WPS® pump is fitted with a 230V Well Pumps motor and by means of the built-in frequency converter it is driven at a constant speed of 8200 RPM, 140Hz. Every time the pump is put on the supply (1~230) , a soft start will be performed.

Pump and motor range

3"WPS® and 3"WPS®-CP pump range consist of four flow models: 1, 2, 3, and 5 m³/h. The pump-end is entirely made out of Stainless steel DIN 1.4301, AISI 304.

3"WPS® and 3"WPS®-CP motors are in Stainless steel DIN 1.4301, AISI 304 and available in three motor powers: 600W, 900W and 1500W.

Pipe connection

All pump types have a threaded pipe connection Rp1 ¼".

The 3"WPS®-CP controller has a flow through design. The in- and outlet are 1 ¼" Male.

Pump identification code

Example

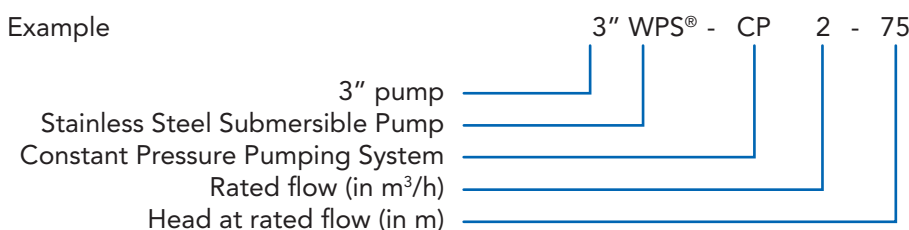

Pumped liquids

3"WPS® and 3"WPS®-CP pumps are designed for pumping thin, clean, non-aggressive and non-explosive liquids, not containing solid particles.

3"WPS® and 3"WPS®-CP pumps are suitable for pumping liquids with a content of sand up to 150 g/m³. A higher content of sand reduce the pump lifetime.

The maximum fluid temperature is 30°C. For higher temperatures, please contact Well Pumps.



3"WPS®(-CP)

Features and benefits

Dry-running protection

3" WPS® and 3" WPS®-CP pumps are protected against dry running.

The **3" WPS®-CP** controller is equipped with a flow sensor that at all times measures the pumped flow. As soon as this flow drops under a minimum value (Q_{min} is about $0,1\text{ m}^3/\text{h}$), the pump will be stopped. Simultaneously, also the absorbed power of the motor is measured. A minimum value of this power ensures cut-out of the pump. Both these measurements ensure in case of lack of water in the borehole, a shutdown of the pump and thus preventing a burnout of the motor.

The **3" WPS®** motor includes a built-in controller that is factory-set with a cut-out power and which continuously tracks the absorbed power of the pump. In case of lack of water in the borehole, the absorbed power by the pump will be reduced below the $P_{cut-out}$. Consequently the pump will be stopped and thus prevent a burnout of the motor. The pump will automatically restart after 20 minutes which gives time to the well to recover. In case of a second dry run the pump will wait for 45 minutes before an automatic restart. At the 3rd dry run, the pump will wait for 6 hours and the fourth time for 24 hours. If a 5th dry run occurs, the pump goes in permanent error and has to be reset by taking off the supply from the motor.

High pump efficiency and Wear resistance

The WPS® pumps are entirely made of stainless steel and ensure a high efficiency meaning low energy consumption and therefore low energy costs.

Due to its stainless steel construction in combination with the high performance NBR seals and bearings, the 3" WPS® and 3" WPS®-CP pumps ensure high wear resistance to sand for long product life.

Excellent starting capabilities

The integrated electronic unit of the 3" WPS® and 3" WPS®-CP controller features soft starting. A soft start reduces the starting current and gives the pump a smooth and steady acceleration.

A soft starter minimizes the risk of wear of the pump and prevents overloading of the supply during start-up.

The high starting reliability also applies in case of low voltage supply.

Overvoltage and undervoltage protection

Overvoltage and undervoltage may occur in case of unstable voltage supply.

The integrated protection of all three motor versions prevents damage to the motor in case the voltage moves outside the permissible voltage range.

The 3" WPS®-CP pump will be cut out if voltage falls below 185V or rises above 260V and for the 3" WPS® models below 160V or over 260V. The motor will restart automatically when the voltage is reestablished within the permissible voltage range.

Therefore no extra protection relay is needed.

Overload protection

Exposure of the pump to heavy load causes the current consumption to rise. When the maximum allowed current is exceeded, the pump will be stopped.

Also a locked rotor will automatically be detected and the power supply cut out. Consequently, no extra motor protection is needed.

The 3" WPS® pumps have an extra feature that automatically reduce the speed of the pump when overload occurs. Lower speed means lower power and thus reduction of the absorbed amps. In the case the pump is running at 60Hz and still overloading, the pump will stop and automatically restart after one hour.

Overtemperature protection

The electronic unit of the 3"WPS® and 3"WPS®-CP controller has a built-in temperature sensor. The 3"WPS®-CP controller will cut out the pump when the temperature of the fluid rises over its limit of 55°C. The error code 'Inverter Error' will be mentioned on the display of the 3"WPS®-CP controller. When the temperature has dropped to 45°C, the motor is automatically restarted. The 3"WPS® motor will reduce the speed as soon as the internal temperature in the motor reaches 80°C. This way the absorbed amps and consequently the dissipated heat of the motor will be reduced. In case that at 60Hz the temperature is still not reduced, the pump will shut off and restart automatically after one hour.

Protection against lightning

A surge arrester is built in the motor of the 3"WPS® pumps and is designed to protect the motor from damaging effects of spikes and transients caused by small lightning, electrical motor cycling or any other sudden change in electrical power flow on the supply line.

Reliability

The motors have been constructed with a view to high reliability and have the following features:

- Top quality high speed ball bearings.
- An efficient internal food grade oil circulation in the motor transfers the heat away from the rotor, stator and ball bearings and ensures an optimum operating condition for the motor.

Variable speed (only for 3"WPS®-CP units)

The 3"WPS®-CP controller enables continuously variable speed control within the 5740 and 8200 rpm. The pump can operate in any duty point in the range between the 5740 and 8200 rpm performance curves of the pump. Consequently, the pump performance can be adapted to any specific requirement. On the basis of a required head the speed of the motor is calculated.

Auxiliary contact for Second set-pressure or Remote on/off switch (only for 3"WPS®-CP units)

The 3"WPS®-CP controller is standard equipped with an auxiliary contact that can be activated by changing a specific parameter in the programming of the 3"WPS®-CP controller. The auxiliary contact can be used as a remote on/off switch (f.e. only run the pump when the irrigation is running, extra protection of the pump against dry running in a tank or cistern with a float switch, ...) or to create a second constant pressure level (f.e. higher pressure level when the irrigation system runs, lower pressure level to back-wash a water treatment system, ...)

Performance Curves

3"WPS®(-CP)

Performance Curves 3"WPS® 1 and 3"WPS®-CP 1

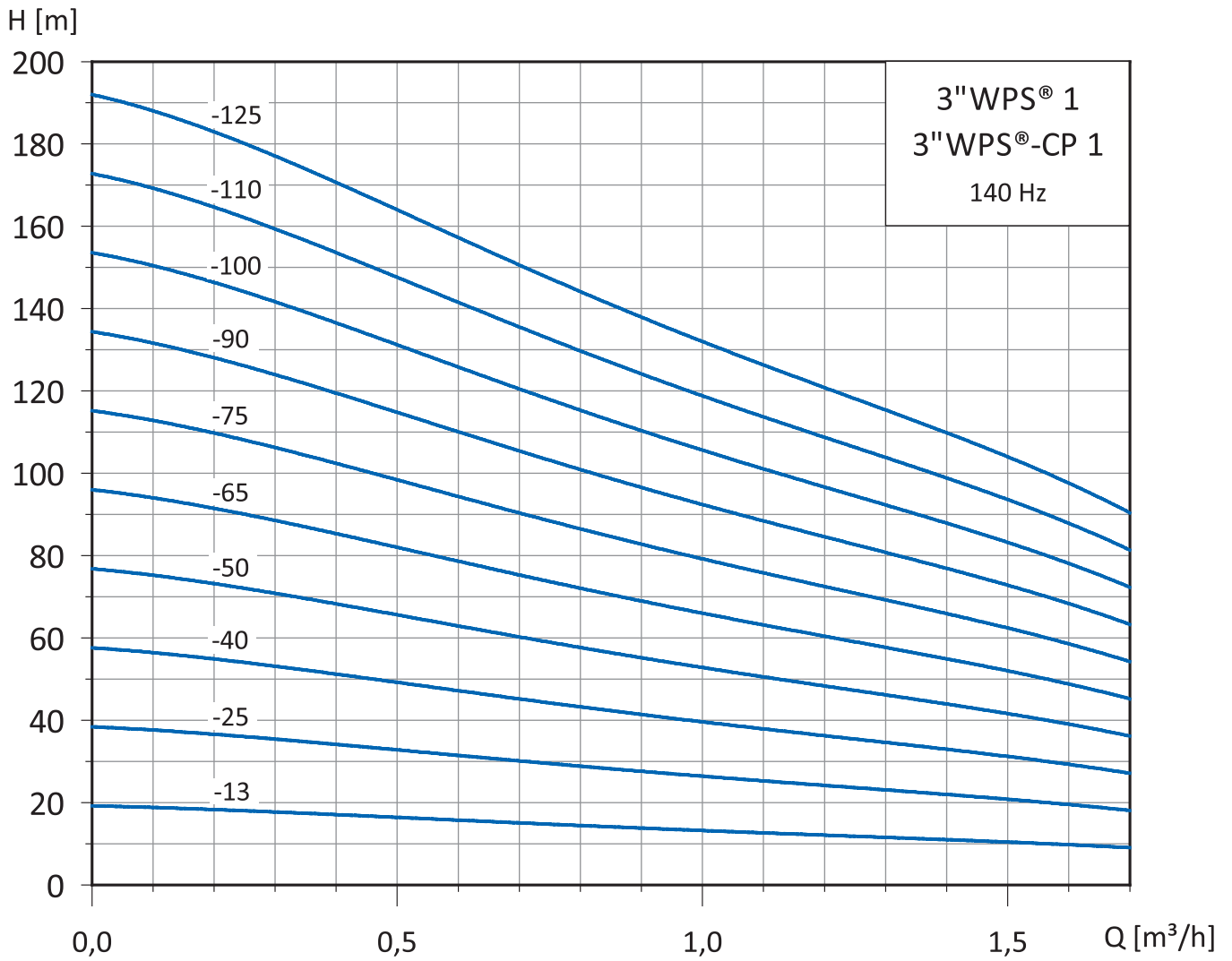

Selection Chart 3"WPS® 1 and 3"WPS®-CP 1

Pump Type	Max. Pump Power [kW]	Flow [m³/h]				Max. head [m] at 0 m³/h	Full load current	
		0,5	1	1,5	2		Motor [A]	Supply [A]
3" WPS®-CP 1-13	0,15	17	13	10	6	20	1,9	3,3
3" WPS® 1-25	0,29	33	26	21	12	39	2,3	3,9
3" WPS®-CP 1-25								3,8
3" WPS® 1-40	0,44	50	40	31	18	59	2,7	4,8
3" WPS®-CP 1-40								4,7
3" WPS® 1-50	0,58	66	53	42	24	78	3,1	5,6
3" WPS®-CP 1-50								5,4
3" WPS® 1-65	0,73	83	66	52	30	98	4,1	7,2
3" WPS®-CP 1-65								7,1
3" WPS® 1-75	0,87	100	79	62	36	117	4,6	8,0
3" WPS®-CP 1-75								8,0
3" WPS® 1-90	1,02	116	92	73	42	137	6,1	10,5
3" WPS®-CP 1-90								10,6
3" WPS® 1-100	1,16	133	106	83	48	156	6,5	11,2
3" WPS®-CP 1-100								11,3
3" WPS® 1-110	1,31	149	119	94	54	176	6,9	11,9
3" WPS®-CP 1-110								12,0
3" WPS® 1-125	1,45	166	132	104	60	195	7,2	12,5
3" WPS®-CP 1-125								12,5

Dimensions and Weights 3"WPS® 1 and 3"WPS®-CP 1

Pump Type	Num. of stage	Max Pump power P ₂ [kW]	Pump data				Kit CP	
			A [mm]	B [mm]	C [mm]	Weight [kg]	Dim. [cm]	Weight [kg]
3" WPS®-CP 1-13	1	0,15	160	210	370	5,1	65x32x22	11,2
3" WPS® 1-25	2	0,29	180	635	815	7,7	65x32x22	10,4
3" WPS®-CP 1-25								
3" WPS® 1-40	3	0,44	200	635	835	7,9	65x32x22	11,6
3" WPS®-CP 1-40								
3" WPS® 1-50	4	0,58	220	635	855	8,1	65x32x22	11,8
3" WPS®-CP 1-50								
3" WPS® 1-65	5	0,73	240	692	932	9,0	65x32x22	12,7
3" WPS®-CP 1-65								
3" WPS® 1-75	6	0,87	260	692	952	9,2	65x32x22	12,9
3" WPS®-CP 1-75								
3" WPS® 1-90	7	1,02	280	845	1125	10,0	65x32x22	13,7
3" WPS®-CP 1-90								
3" WPS® 1-100	8	1,16	300	845	1145	10,2	65x32x22	13,9
3" WPS®-CP 1-100								
3" WPS® 1-110	9	1,31	320	845	1165	10,4	65x32x22	14,1
3" WPS®-CP 1-110								
3" WPS® 1-125	10	1,45	340	845	1185	10,6	65x32x22	14,3
3" WPS®-CP 1-125								

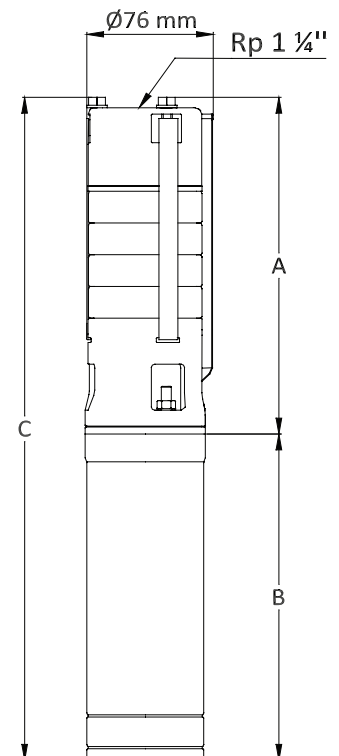

Performance Curves

3"WPS®(-CP)

Performance Curves 3"WPS® 2 and 3"WPS®-CP 2

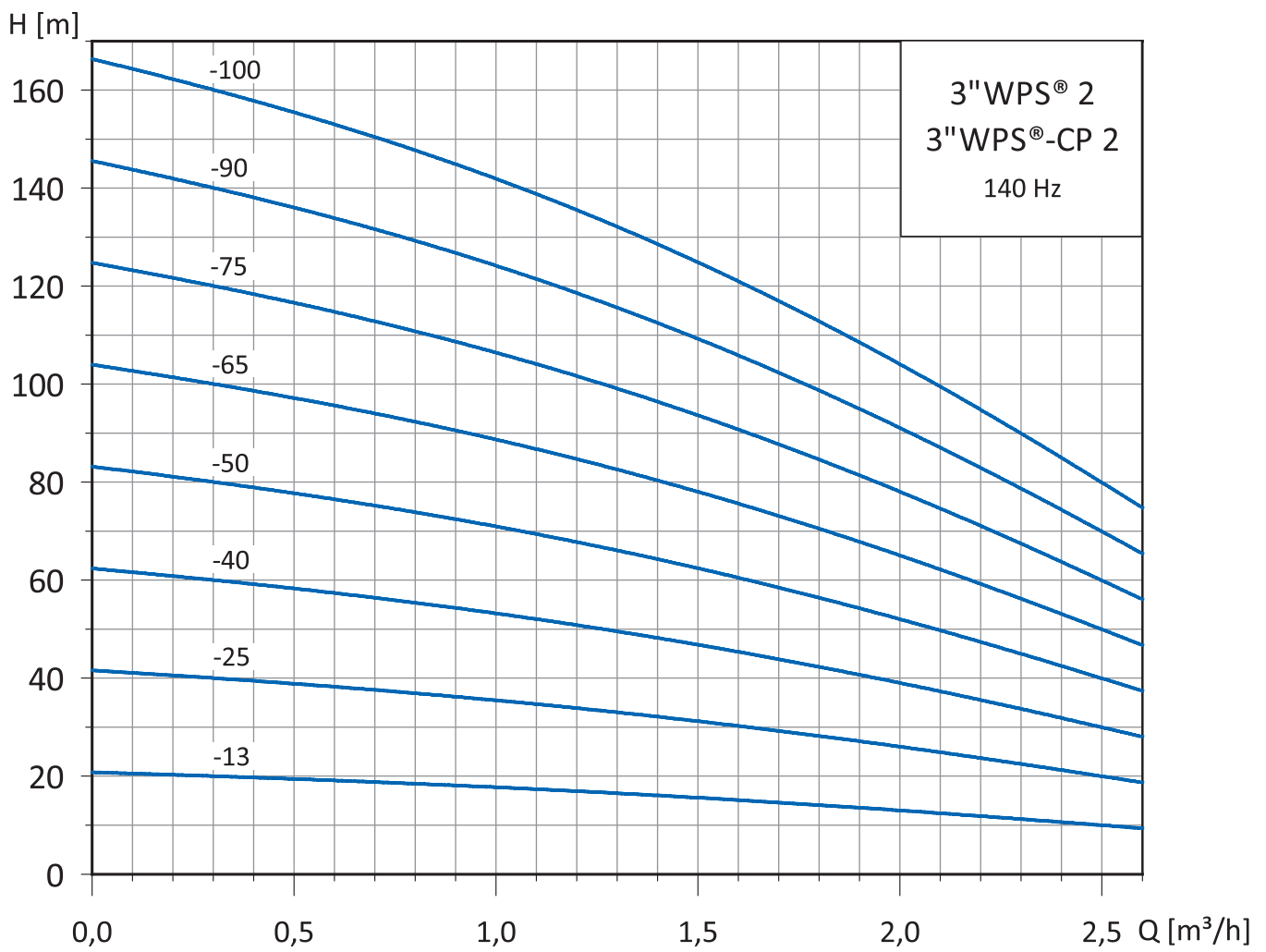

Selection Chart 3"WPS® 2 and 3"WPS®-CP 2

Pump Type	Max. Pump Power [kW]	Flow [m³/h]					Max. head [m] at 0 m³/h	Full load current	
		0,5	1	1,5	2	2,5		Motor [A]	Supply [A]
3" WPS®-CP 2-13	0,19	20	18	16	13	10	21	2,0	3,5
3" WPS® 2-25	0,37	39	36	31	26	20	42	2,5	4,5
3" WPS®-CP 2-25								4,4	
3" WPS® 2-40	0,56	59	53	47	39	30	62	3,1	5,5
3" WPS®-CP 2-40								5,4	
3" WPS® 2-50	0,74	78	71	62	52	40	83	4,1	7,0
3" WPS®-CP 2-50								7,1	
3" WPS® 2-65	0,90	98	89	78	65	50	104	4,7	8,2
3" WPS®-CP 2-65								8,2	
3" WPS® 2-75	1,11	117	107	93	78	60	125	6,1	10,5
3" WPS®-CP 2-75								10,6	
3" WPS® 2-90	1,29	137	124	109	91	70	145	6,8	11,7
3" WPS®-CP 2-90								11,8	
3" WPS® 2-100	1,48	156	142	124	104	80	166	7,2	12,5
3" WPS®-CP 2-100								12,5	

3"WPS®(-CP)

Dimensions and Weights 3"WPS® 2 and 3"WPS®-CP 2

Pump Type	Num. of stage	Max Pump power P ₂ [kW]	Pump data				Kit CP	
			A [mm]	B [mm]	C [mm]	Weight [kg]	Dim. [cm]	Weight [kg]
3" WPS®-CP 2-13	1	0,19	160	210	370	5,1	65x32x22	11,2
3" WPS® 2-25	2	0,37	180	615	795	7,7	65x32x22	10,4
3" WPS®-CP 2-25								
3" WPS® 2-40	3	0,56	200	615	815	7,9	65x32x22	11,6
3" WPS®-CP 2-40								
3" WPS® 2-50	4	0,74	220	645	865	8,9	65x32x22	12,6
3" WPS®-CP 2-50								
3" WPS® 2-65	5	0,90	240	645	885	9,1	65x32x22	12,8
3" WPS®-CP 2-65								
3" WPS® 2-75	6	1,11	260	815	1075	10,0	65x32x22	13,7
3" WPS®-CP 2-75								
3" WPS® 2-90	7	1,29	280	815	1095	10,2	65x32x22	13,9
3" WPS®-CP 2-90								
3" WPS® 2-100	8	1,48	300	815	1115	10,4	65x32x22	14,1
3" WPS®-CP 2-100								

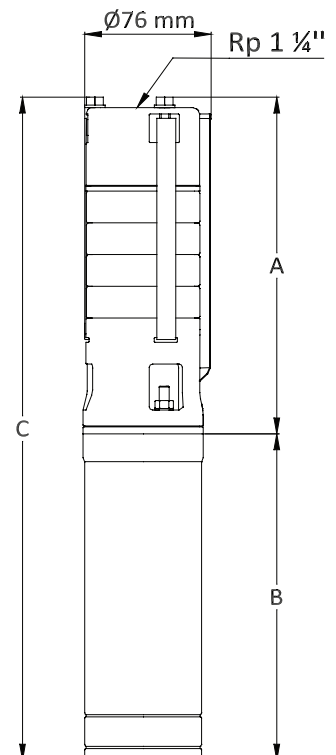

Performance Curves

3"WPS®(-CP)

Performance Curves 3"WPS® 3 and 3"WPS®-CP 3

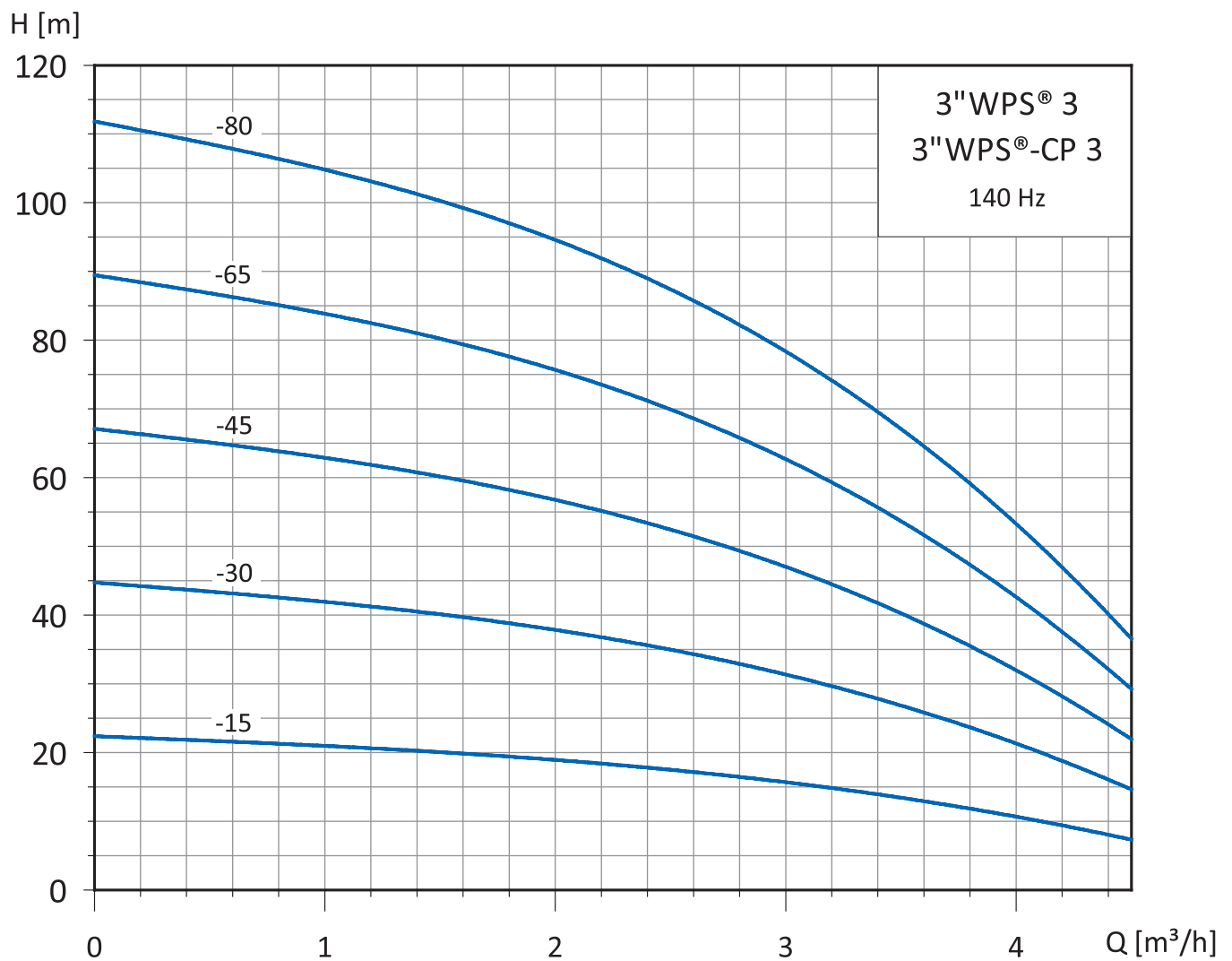

Selection Chart 3"WPS® 3 and 3"WPS®-CP 3

Pump Type	Max. Pump Power [kW]	Flow [m³/h]						Max . head [m] at 0 m³/h	Full load current	
		1	2	2,5	3	3,5	4		Motor [A]	Supply [A]
3" WPS® 3-15 3" WPS®-CP 3-15	0,29	21	19	17	16	13	10	22	2,8	4,9
3" WPS® 3-30 3" WPS®-CP 3-30	0,58	42	37	34	31	26	21	45	3,1	5,5
3" WPS® 3-45 3" WPS®-CP 3-45	0,87	62	56	52	47	40	31	67	4,6	7,9
3" WPS® 3-65 3" WPS®-CP 3-65	1,16	83	74	69	62	53	42	90	6,3	10,8
3" WPS® 3-80 3" WPS®-CP 3-80	1,45	104	93	86	78	66	52	112	7,1	12,3

3"WPS®(-CP)

Dimensions and Weights 3"WPS® 3 and 3"WPS®-CP 3

Pump Type	Num. of stage	Max Pump power P ₂ [kW]	Pump data				Kit-CP	
			A [mm]	B [mm]	C [mm]	Weight [kg]	Dim. [cm]	Weight [kg]
3" WPS® 3-15 3" WPS®-CP 3-15	1	0,29	160	635	795	6,5	65x32x22	11,2
3" WPS® 3-30 3" WPS®-CP 3-30	2	0,58	180	635	915	6,8		10,4
3" WPS® 3-45 3" WPS®-CP 3-45	3	0,87	200	695	895	8,7	65x32x22	12,4
3" WPS® 3-65 3" WPS®-CP 3-65	4	1,16	220	845	1065	9,7		13,4
3" WPS® 3-80 3" WPS®-CP 3-80	5	1,45	240	845	1085	9,9	65x32x22	13,6
				270	510	7,5		

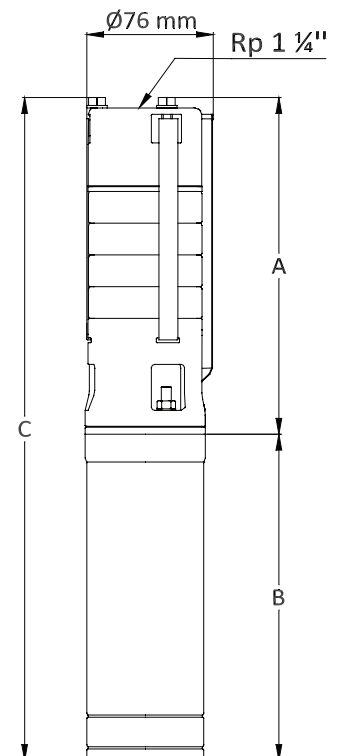

Performance Curves

3"WPS®(-CP)

Performance Curves 3"WPS® 5 and 3"WPS®-CP 5

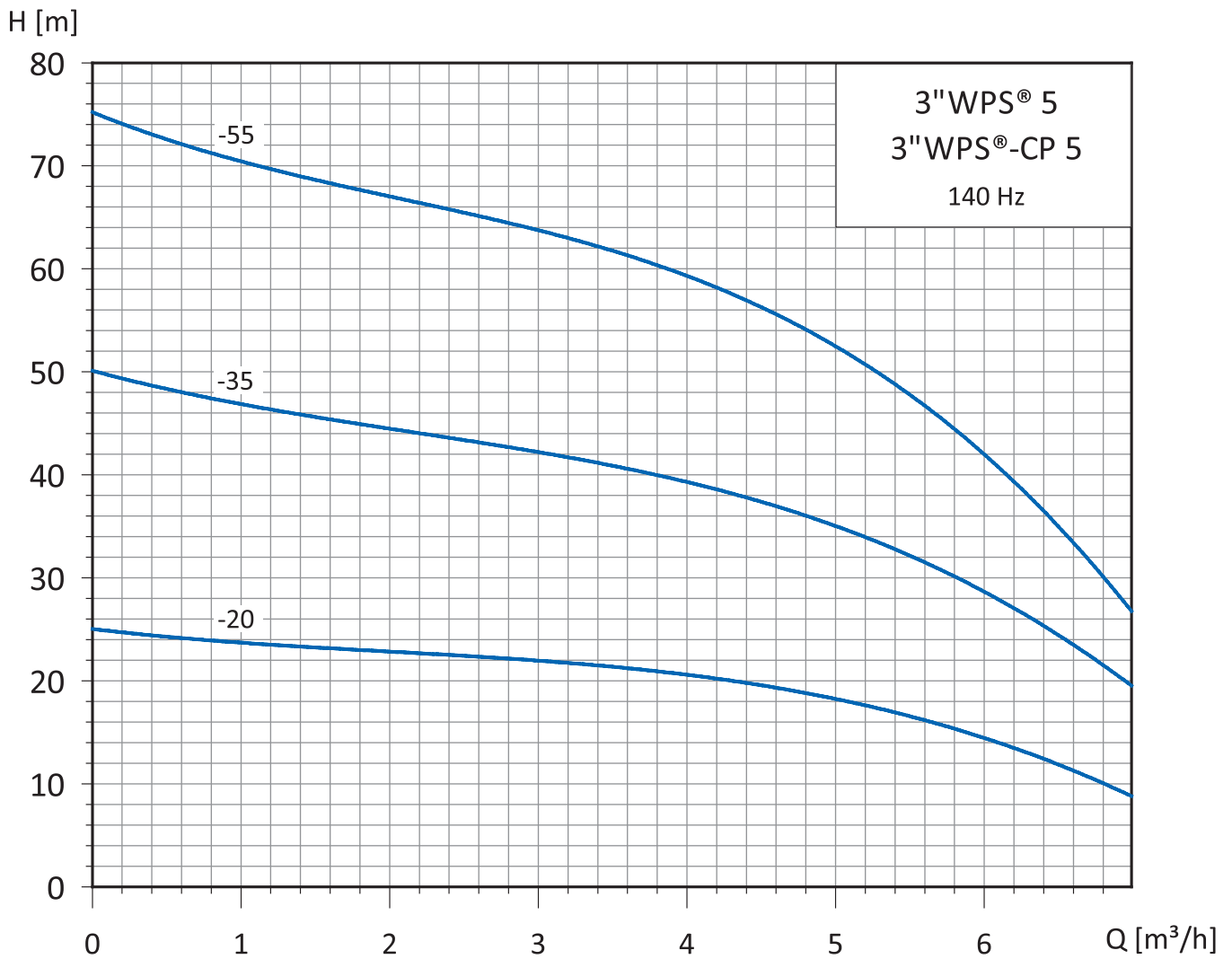

Selection Chart 3"WPS® 5 and 3"WPS®-CP 5

Pump Type	Max. Pump Power [kW]	Flow [m³/h]						Max . head [m] at 0 m³/h	Full load current	
		1	2	3	4	5	6		Motor [A]	Supply [A]
3" WPS® 5-20 3" WPS®-CP 5-20	0,45	24	23	21	21	18	15	25	3,2	5,6
3" WPS® 5-35 3" WPS®-CP 5-35	0,90	47	44	42	39	35	29	50	4,7	8,2
3" WPS® 5-55 3" WPS®-CP 5-55	1,35	70	67	64	59	53	42	75	7,2	12,5

Dimensions and Weights 3"WPS® 5 and 3"WPS®-CP 5

Pump Type	Num. of stage	Max Pump power P ₂ [kW]	Pump data				Kit-CP	
			A [mm]	B [mm]	C [mm]	Weight [kg]	Dim. [cm]	Weight [kg]
3" WPS® 5-20 3" WPS®-CP 5-20	1	0,45	160	635	795	7,5	65x32x22	11,2
3" WPS® 5-35 3" WPS®-CP 5-35	2	0,90	180	695	875	8,5		
3" WPS® 5-55 3" WPS®-CP 5-55	3	1,35	200	845	1045	9,5	65x32x22	13,2
				270	470	7,1		

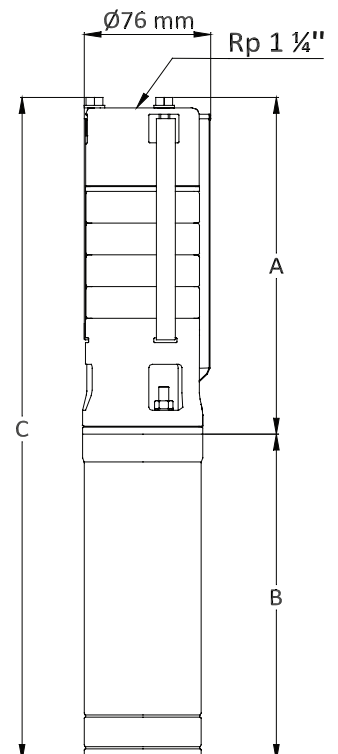

Technical Data

3" WPS® (CP)

Cable selection

3" WPS®

Submersible drop cable to the motor (single phase)

The table below shows the maximum length of the submersible drop cable between the supply and the motor for the different cable sizes and motor powers.

The cross-sections of the cable are calculated according to a 3% voltage drop (IEC 60364:2001). The pump will cut out if the supply voltage falls below 160 V.

Pump Type	P ₂ [kW]	I _n [A]	Maximum cable length [m]. Cable section AWG/mm ²								
			14 AWG			12 AWG		10 AWG		8 AWG	
			1,5	2,1	2,5	3,3	4	5,3	6	8,4	10
3" WPS® 1-40	0,44	3,9	120	168	200	264	320	424	480	672	800
3" WPS® 1-50	0,58	4,8	98	137	163	215	260	345	390	546	650
3" WPS® 1-65	0,73	6,0	78	109	130	172	208	276	312	437	520
3" WPS® 1-75	0,87	7,1	66	92	110	145	176	233	264	369	439
3" WPS® 1-90	1,02	8,1	58	81	69	127	154	204	231	324	385
3" WPS® 1-100	1,16	9,1	51	72	86	113	137	182	206	288	343
3" WPS® 1-110	1,31	10,0	47	66	78	103	125	165	187	262	312
3" WPS® 1-125	1,45	11,8	40	56	66	87	106	140	159	222	264
3" WPS® 2-25	0,37	3,6	130	182	217	286	347	459	520	728	867
3" WPS® 2-40	0,56	5,0	94	131	156	206	250	331	374	524	624
3" WPS® 2-50	0,74	5,9	79	111	132	175	212	280	317	444	529
3" WPS® 2-65	0,90	7,2	65	91	108	143	173	230	260	364	433
3" WPS® 2-75	1,11	8,9	53	74	88	116	140	186	210	294	351
3" WPS® 2-90	1,29	9,9	47	66	79	104	126	167	189	265	315
3" WPS® 2-100	1,48	12,0	39	55	65	86	104	138	156	218	260
3" WPS® 3-30	0,58	4,5	104	146	173	229	277	367	416	582	693
3" WPS® 3-45	0,87	6,0	78	109	130	172	208	276	312	437	520
3" WPS® 3-65	1,16	8,2	57	80	95	126	152	202	228	320	381
3" WPS® 3-80	1,45	10,2	46	64	76	101	122	162	184	257	306
3" WPS® 5-20	0,45	4,0	117	164	195	257	312	413	468	655	780
3" WPS® 5-35	0,90	7,6	62	86	103	135	164	218	246	345	411
3" WPS® 5-55	1,35	11,0	43	60	71	94	113	150	170	238	284

Cable selection

3"WPS®-CP

Submersible drop cable to the motor (three phase)

The table below shows the maximum length of the submersible drop cable between the controller and the motor for the different cable sizes and motor powers.

The cross-sections of the cable are calculated according to a 3% voltage drop (IEC 60364:2001).

The pump will cut out if the supply voltage falls below 185 V.

Pump Type	P ₂ [kW]	In [A]	Maximum cable length [m]. Cable section AWG/mm ²									
			14 AWG		12 AWG		10 AWG		8 AWG		10	
			1,5	2,1	2,5	3,3	4	5,3	6	8,4		
3"WPS®-CP 1-40	0,44	2,7	125	175	209	276	334	443	501	701	835	
3"WPS®-CP 1-50	0,58	3,1	109	153	182	240	291	385	436	611	727	
3"WPS®-CP 1-65	0,73	4,1	82	115	137	181	220	291	330	462	550	
3"WPS®-CP 1-75	0,87	4,6	74	103	123	162	196	260	294	412	490	
3"WPS®-CP 1-90	1,02	6,1	55	78	92	122	148	196	222	310	370	
3"WPS®-CP 1-100	1,16	6,3	54	75	89	118	143	190	215	301	358	
3"WPS®-CP 1-110	1,31	6,5	52	73	87	114	139	184	208	291	347	
3"WPS®-CP 1-125	1,45	6,9	49	69	82	108	131	173	196	274	327	
3"WPS®-CP 2-25	0,37	2,5	135	189	225	298	361	478	541	757	902	
3"WPS®-CP 2-40	0,56	3,1	109	153	182	240	291	385	436	611	727	
3"WPS®-CP 2-50	0,74	4,2	81	113	134	177	215	284	322	451	537	
3"WPS®-CP 2-65	0,90	4,7	72	101	120	158	192	254	288	403	480	
3"WPS®-CP 2-75	1,11	6,0	56	79	94	124	150	199	225	316	376	
3"WPS®-CP 2-90	1,29	6,9	49	69	82	108	131	173	196	274	327	
3"WPS®-CP 2-100	1,48	7,3	46	65	77	102	124	164	185	259	309	
3"WPS®-CP 3-30	0,58	2,8	121	169	201	266	322	427	483	676	805	
3"WPS®-CP 3-45	0,87	4,1	82	115	137	181	220	291	330	462	550	
3"WPS®-CP 3-65	1,16	5,5	61	86	102	135	164	217	246	344	410	
3"WPS®-CP 3-80	1,45	6,6	51	72	85	113	137	181	205	287	342	
3"WPS®-CP 5-20	0,45	2,8	121	169	201	266	322	427	483	676	805	
3"WPS®-CP 5-35	0,90	4,7	72	101	120	158	192	254	288	403	480	
3"WPS®-CP 5-55	1,35	7,4	46	64	76	101	122	161	183	256	305	

In case the total length of the electrical power cable between controller and motor exceeds 100m, an extra filter to protect the motor from burning is required. See accessories.

Supply cable to the controller (single phase)

In case you want a longer electrical cable, you must check the cable section following the table below. Maximal cable length for specific cable sections:

Motor Size	1,5 mm ²	2,5 mm ²	4 mm ²	6 mm ²
600 W	70 m	120 m	180 m	270 m
900 W	50 m	80 m	125 m	190 m
1500 W	35 m	60 m	90 m	140 m

Technical Data

3" WPS® (CP)

Material specification

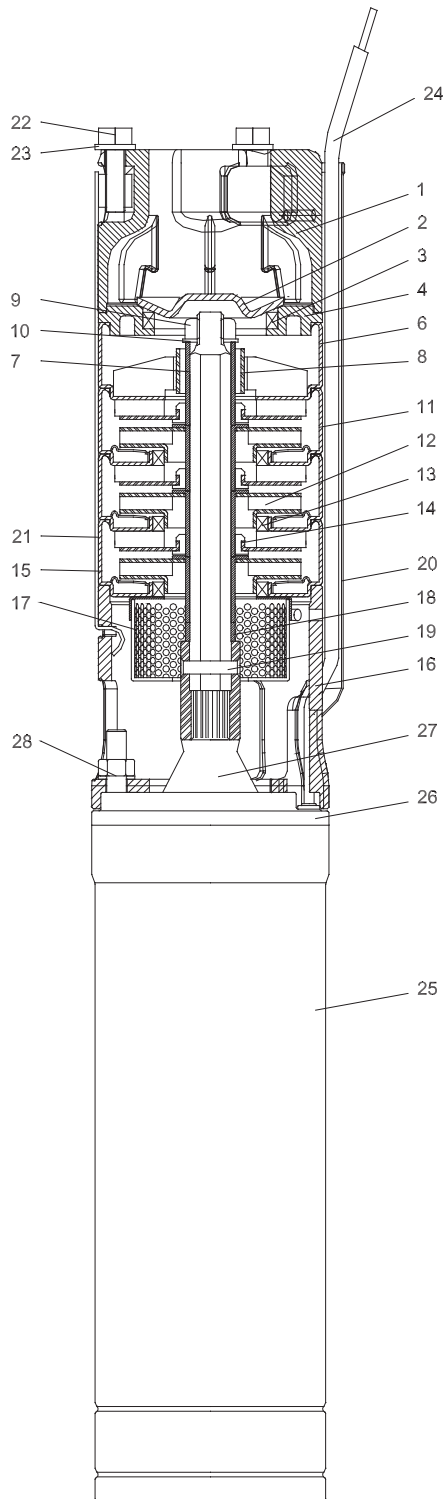

Pos.	Component	Material	Material code
1	Discharge Chamber	Stainless Steel	AISI 304 - 1.4301
2	Valve Cone	Stainless Steel	AISI 304 - 1.4301
3	Valve Seat	Stainless Steel/NBR	AISI 304 - 1.4301
4	Retainer for Valve Seat	Stainless Steel	AISI 304 - 1.4301
5	Up-trust Washer	Teflon	PTFE
6	Top Diffuser	Stainless Steel	AISI 304 - 1.4301
7	Top Spacer	Stainless Steel	AISI 304 - 1.4301
8	Top Bearing	Stainless Steel/NBR	AISI 304 - 1.4301
9	Nut M8	Stainless Steel	AISI 304 - 1.4301
10	Washer M8	Stainless Steel	AISI 304 - 1.4301
11	Diffuser	Stainless Steel	AISI 304 - 1.4301
12	Impeller	Stainless Steel	AISI 304 - 1.4301
13	Neck Ring	Stainless Steel/NBR	AISI 304 - 1.4301
14	Intermediate Bearing	NBR	
15	Bottom Diffuser	Stainless Steel	AISI 304 - 1.4301
16	Section interconnector	Stainless Steel	AISI 304 - 1.4301
17	Strainer	Stainless Steel	AISI 304 - 1.4301
18	First Spacer	Stainless Steel	AISI 304 - 1.4301
19	Shaft with coupling	Stainless Steel	AISI 304 - 1.4301
20	Cable Gard	Stainless Steel	AISI 304 - 1.4301
21	Strap	Stainless Steel	AISI 304 - 1.4301
22	Bolt M6	Stainless Steel	AISI 304 - 1.4301
23	Washer M6	Stainless Steel	AISI 304 - 1.4301
24	Motor Lead with plug		
25	Motor Stator	Stainless Steel	AISI 304 - 1.4301
26	Motor Top Cover	Stainless Steel	AISI 304 - 1.4301
27	Shaft Seal	NBR	
28	Nut and Washer M6	Stainless Steel	AISI 304 - 1.4301

Submersible drop cable to the motor (drinking water quality)

3"WPS®-CP

4-core submersible cable including earth conductor (three phase motor). This blue cable is approved for drinking water applications (KTW approval). When ordering please state length [m]



Description	Cross Section of leads	Reference
Submersible cable 4G1,5	1,5 mm ²	9105
Submersible cable 4G2,5	2,5 mm ²	9106
Submersible cable 4G4	4 mm ²	9107
Submersible cable 4G6	6 mm ²	9108

3"WPS®

3-core submersible cable including earth conductor (single phase supply). This blue cable is approved for drinking water applications (KTW approval). When ordering please state length [m]



Description	Cross Section of leads	Reference
Submersible cable 3G1,5	1,5 mm ²	9101
Submersible cable 3G2,5	2,5 mm ²	9102
Submersible cable 3G4	4 mm ²	9103
Submersible cable 3G6	6 mm ²	9104

Submersible cable joint kit

For watertight shrink-joining of motor cable and submersible drop cable (round or flat cable). The joint is ready for use after a few minutes and requires no long hardening time as do resin joints.



Description	Cross Section of leads	Reference
Submersible cable joint kit 1,5-2,5	1,5-2,5 mm ²	9200
Cable joint 1,5-2,5 mm ² fitted to the drop cable	1,5-2,5 mm ²	9300
Submersible cable joint kit 4-6	4-6 mm ²	9201
Cable joint 4-6 mm ² fitted to the drop cable	4-6 mm ²	9301

Straining Wire

The stainless steel wire retains the submersible pump. Special openings are made in the discharge chamber to fix the wire to the pump. When ordering please state the requested length [m].



Material	Diameter	Reference
Stainless steel DIN W.-Nr. 1.4401, Aisi 316	Ø 3 mm	71003

Accessories

3" WPS® (-CP)

Wire clamps



Two units are needed per loop. This means per installation 4 wire clamps are recommended.

Material	Diameter	Reference
Stainless steel DIN W.-Nr. 1.4401, Aisi 316	Ø 3 mm	71103

Filters



- Motor side (only for 3" WPS®-CP): When the drop cable between the controller and the pump exceeds more than 100m, an extra filter to protect the motor from burning is required.

Description	Max. length drop cable	Reference
WPS® 200MF Filter	200 m	7200
WPS® 400MF Filter	400 m	7210

- Supply side (for both 3" WPS®-CP and 3" WPS® pumps) : Radio frequency interference is the radiation or conduction of radio frequency energy (or electronic noise) produced by electrical and electronic devices at levels that interfere with the operation of adjacent equipment. In case you experience phenomena, please install the WPS® RFI Power Line Filter.

Description	Reference
WPS® RFI Power Line Filter	7220

Cooling Shrouds

The cooling shrouds are designed to ensure a sufficient flow velocity past the motor in order to provide sufficient cooling. For the following cases a cooling shroud is recommended:

- horizontal or vertical installation in a tank
- installation of the pump in the screen from the well
- installation in big sized well not ensuring enough cooling velocity. See table.

Minimum flow required for motor cooling in water up to 20°C.	
Casing or sleeve I.D. [mm (inches)]	3" motor, cooling flow 8 cm/sec [m³/h]
78 (3")	0,2
102 (4")	1,1
127 (5")	2,4
152 (6")	4,0

To the shroud itself, a screen can be added. In case of horizontal installation a set of supports are available. The screen can be changed by an adaptor with floating screen ensuring water intake about 20cm under the water level and prevent clogging of the pump due to sand or other sediments on the bottom of the tank, lake, ...

3"WPS®-CP

Description	Material	Pump with motor	Reference
Shroud Ø88x350mm	1.4301 AISI304	600W	73020
Shroud Ø88x450mm	1.4301 AISI304	900W - 1500W	73030

3"WPS®

Description	Material	Pump with motor	Reference
Shroud Ø88x900mm	1.4301 AISI304	All types	73010

3"WPS® and 3" WPS® CP

Description	Material	Pump with motor	Reference
Screen Ø88x90mm	1.4301 AISI304	All types	73300
Floating screen	1.4301 AISI304	All types	73310

Description	Material	Reference
Set of supports for horizontal installation	1.4301 AISI304	73400

3"WPS®(-CP)



Complete horizontal installation of 3"WPS®-CP pump with shroud, screen and set of support



3" WPS® - CP pump with floating screen